



SAVER™ 3X90



SAVER™ 3X90 is a self-powered field data recorder with an internal tri-axial accelerometer, temperature and humidity sensors, and USB connectivity. Powered with 9V lithium batteries, the instrument will operate continuously for up to 90 days. 16-bit resolution electronics allow you to take precise measurements of your dynamic environment.

Measure



Test



Monitor



Field-to-Lab™

- Measure**
Measure transport hazards in the field.
- Test**
Use the results to construct laboratory testing.
- Monitor**
Continue monitoring the field to see if anything changes.



SAVER™ 3X90



FEATURES

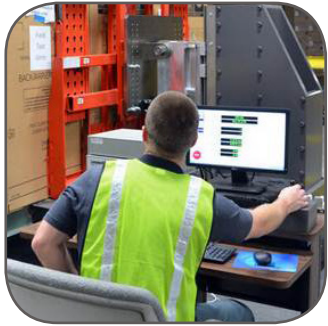

Field-to-Lab®

Use SaverXware™ software to analyze data captured with SAVER™ instruments, and seamlessly create random vibration test profiles that can be easily imported into Lansmont TouchTest Vibration Controllers for immediate use. Only Lansmont offers this cross-platform integration.

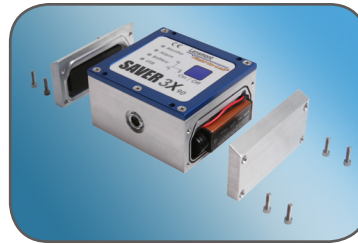

90 Day battery Life:

SAVER™ 3X90 is powered by two 9V batteries located on either side of the unit. The unit will run for 90 days on lithium batteries (45 days

on alkaline batteries). Step-by-step instructions are provided in SaverXware™ for replacing the batteries.



T/RH sensor:

In addition to dynamic measurements, your SAVER™ 3X90 will also capture temperature and relative humidity conditions. Internal sensors mounted to the

back side of the SAVER™ 3X90 measure and record environmental conditions per the user-defined setup.

OPTIONS



External Battery Pack:

For some recording applications, 90 days may not be enough recording time. Not a problem. Lansmont offers an External Battery Pack that extends the continuous operation time from 90 to 250 days.



Mounting Kits:

Mounting kits can make it easier to fix SAVER™ 3X90's to vehicles or structures. Kits include mounting plates and attachment

hardware. If you are attaching to a ferrous surface, magnetic mounting kits are available.

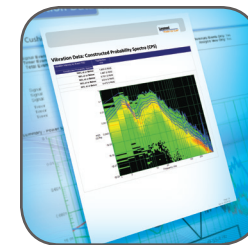

Data Analysis Center:

Trust Lansmont data specialists to interpret your data and provide you with even greater confidence. Lansmont data specialists are experts at acquiring,

analyzing and summarizing data; if you need help defining parameters or protocols, we can help.



SAVER™ 3X90



SaverXware™

Each SAVER™ purchase includes Lansmont's SaverXware™, the easy-to-use software that communicates with the SAVER™ 3X90 for setup prior to recording — as well as data analysis once you've collected some data. Data analysis features include drop heights, impacts, vehicle motion, vibration, as well as temperature and humidity cycles.



Measurement Setup

Users are provided with simple, standard setup gateways for common measurement applications. Advanced setup options provide complete control over all setup parameters, providing unparalleled capability for instrument users.

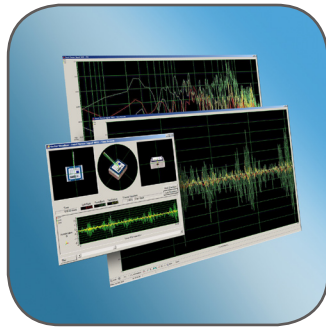

Data Analysis

Powerful individual and multi-event summary analyses providing time-history, frequency domain, and vector visualizer playback and review.

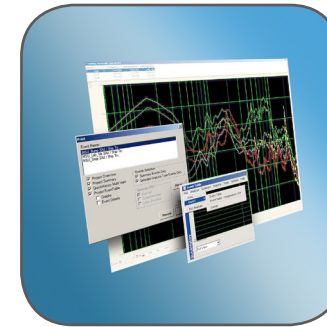

Summary Reporting and Export

Generate user-defined project summary reports and print to document measurement results. Additionally, export the project data itself to ASCII files for analysis and reporting using universally available software applications.



Event Table and History

Multi-data files can be viewed in single, common project databases. The data file's measured events are chronologically presented in event tables, which are positioned underneath measurement Quick Histories. The Quick Histories display the captured data from the project

beginning to end in one view. Corresponding event thumbnails are updated as different events are highlighted in the table.

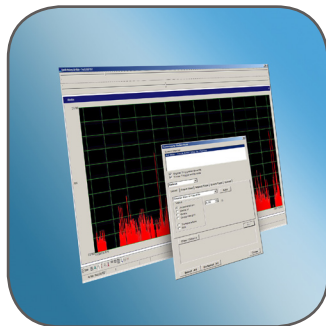

Summary Event Selection

Extremely useful event selection options based upon acceleration and Grms levels, time occurrence, type of event and even impact type and orientation. A quick history zoom-to-summary option with user-defined range cursors is provided as an alternative summary selector.



GPS Integration

Externally captured GPS data can be imported and automatically synchronized with SAVER™ 3X90 data to add further value and definition to your measurement results.



SAVER™ 3X90



MEASUREMENT APPLICATIONS

Do you know what kinds of hazards your products must endure within their transport or in-use environments? The SAVER™ 3X90 Field Instrument is the right tool for thoroughly measuring dynamic and climatic conditions in manufacturing, transport, and in-use environments.



Manufacturing

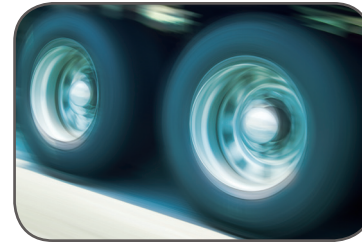

Vehicles



Structural Measurements



Asset Transport



Oil Platforms



Amusement Rides

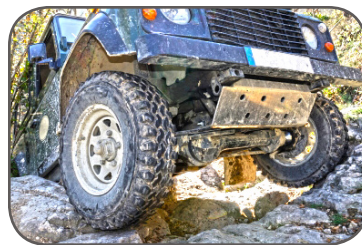

Off Road Measurements



Packages



Aerospace

Effective integration of measurement and monitoring programs provide customers the ability to:

- Characterize the dynamic and climatic hazards within a given environment
- Establish product design criteria
- Develop laboratory testing and simulation criteria
- Audit distribution channels and carriers
- Establish liability in transport damage situations
- Determine normal vs. abnormal handling and transport of your goods
- Create climatic histograms of environmental conditions (Temp/RH)



SAVER™ 3X90



SPECIFICATIONS

PHYSICAL

Size:	3.74 x 2.90 x 1.7 in. (95 x 74 x 43 mm)
Volume:	18.4 in. ³ (302 cm ³)
Chassis Material:	6061-T6 anodized aluminum
Weight:	16.7 oz. (473 grams)
Environmental:	Weather Resistant
Mounting:	4 thru holes for #6 screws

DATA ACQUISITION

Sampling Rates:	50, 100, 200, 250, 500, 1000, 2500, and 5000 samples per second
A/D Conversion:	16-bit
Accelerometer Type:	Tri-axial piezoelectric
Acceleration Ranges:	5, 10, 20, 50, 100, and 200 g (full-scale)
Anti-Alias Filter:	4-pole, low-pass Butterworth filter 10, 20, 50, 100, 200, 250, and 500 Hz (cut-off frequency)
Software Filters:	1 or 2-pole, low-pass RC post-process filters 0 to 10 kHz (cut-off frequency)
3-dB Frequency Response:	0.4 Hz to filter setting
Instrument Noise Floor:	0.02 Grms typical at 500 Hz bandwidth
Dynamic Range:	80 dB typical
Measurement Accuracy:	±5% with nominal variations in temperature and frequency

DATA RECORDING

Signal Trigger:	User programmable acceleration (g) threshold
Timer Trigger:	User programmable "wake-up" interval
Pre-Trigger:	User-programmable signal event pre-trigger
Data Retention Modes:	Max. Overwrite, Fill / Stop, Wrap / Overwrite
Temperature / Humidity:	Temperature and RH readings recorded for each event

MEMORY

Memory Size:	128 MB
Memory Type:	Non-volatile FLASH
Memory Retention:	Retains data even when batteries are exhausted or removed

ENVIRONMENTAL

Operating Temperature:	-40° to +60°C (-40° to +140°F) using lithium batteries -20° to +54°C (-4° to +130°F) using alkaline batteries
Communication Temperature:	0° to +60°C (32° to +140°F)
Temperature Measurement / Accuracy:	-40° to +60°C (-40° to +140°F) ±1.0°C from +5° to +40°C; ±1.5°C from -40° to +60°C
Humidity Measurement / Accuracy:	5% to 95% RH, non-condensing ± 4% from 5% to 95% RH at 25°C

POWER

Internal:	2 lithium or alkaline 9V batteries
External:	4-D Cell battery pack
Continuous Run Times:	90 days using lithium batteries 45 days using alkaline batteries 180 days using 4-D cell battery pack (option)

SOFTWARE / COMMUNICATIONS

User Interface:	SaverXware™ software
Compatibility:	Microsoft Windows® XP (SP3), Vista, 7
COM Interface:	USB 1.1 or 2.0 compatible
Data Rate:	400 kB/s (typical)

CONTROLS AND INDICATORS

Controls:	Run / Stop button
LED Indicators:	Green: Run Red: Alarm Yellow: Stop Green: USB cable connected

SYSTEM DRAWINGS – MOUNTING DIMENSIONS

ISOMETRIC VIEW

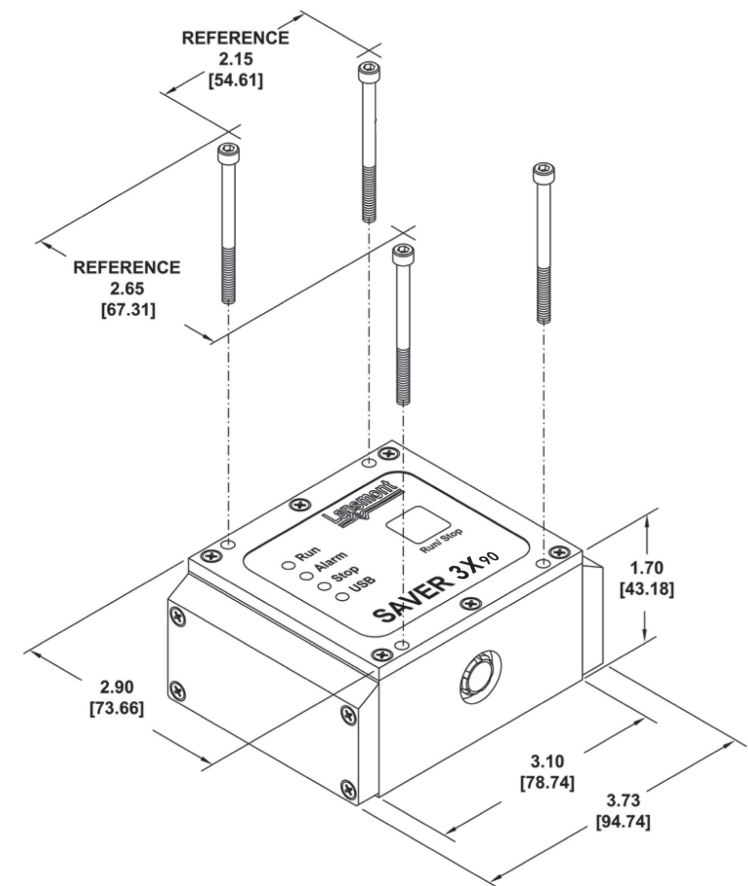

Note: Dimensions in inches [millimeters]